



## SERVICE POLICY

In the event of you needing to contact the Galaxy Customer Service Department, the following procedure should be followed:-

- 1** Before telephoning the Galaxy Customer Service Department you should ensure that you have the model number, serial number and date of purchase.
- 2** The Galaxy Customer Service Department will be able to inform you whether the fault can be rectified by the provision of a replacement part or an on site visit by a Qualified Service Engineer.
- 3** If a service call is booked, you or a representative must be present during the Engineers visit.
- 4** A charge will be made where a call under the terms of the guarantee has been booked and a failure was not product related, or an engineer arrives and is not able to gain access.
- 5** If the product is no longer covered by the Guarantee, a charge will be made for the site visit and for any parts supplied.

**Customer Service Department**

**Telephone: 0845 600 5111 Fax: 01489 773053**

9.00 am - 5.00 pm Monday to Friday



# G1000LX

## Manual Power Shower Installation Instructions

### IMPORTANT!

This Step-by-Step guide should be given to the customer after installation and demonstration.

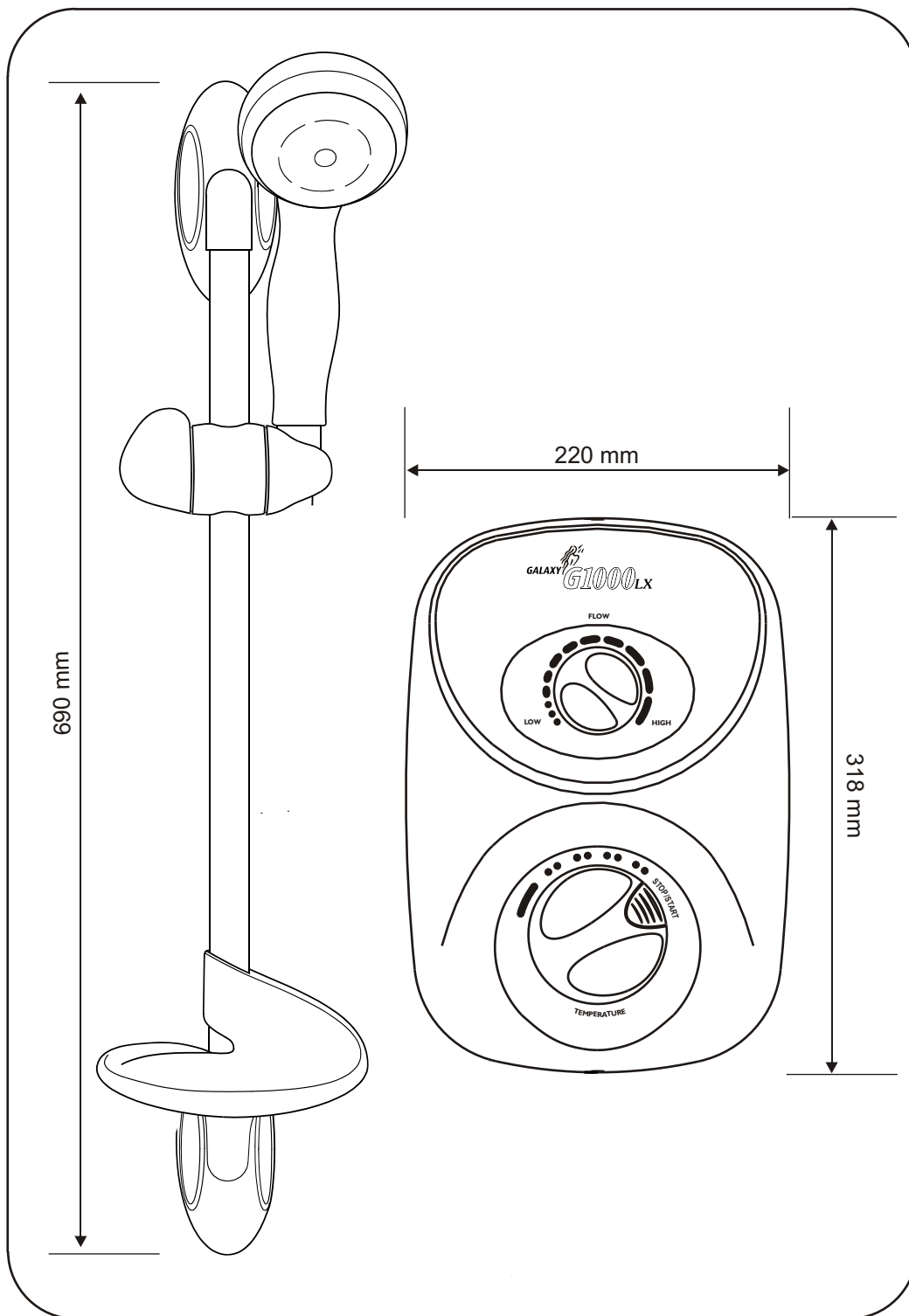

## SECTION 1 PACKING CONTENTS

Shower Unit  
Showerhead  
Showerhead Key  
Flexible Hose  
Slider Rail Tube  
Slider Rail Brackets  
Slider Rail Showerhead Holder  
Soap Dish  
Screw Pack

## SECTION 2 PLUMBING AND ELECTRICAL NOTES

### PLUMBING NOTES

1. All installations must comply with the Water Regulations or Byelaws.
2. Supply pipes must be flushed to clear debris before connecting the shower unit.
3. DO NOT connect the shower unit to the mains cold water supply as it will damage the unit and also be in breach of Water Regulations.
4. DO NOT use excessive force when making connections to the flexible hose or sprayhead – finger tight is sufficient.
5. ALL plumbing connections are to be completed and water supplies turned on BEFORE switching on the electricity supply. The shower must not be operated dry without water.
6. DO NOT solder pipes or fittings within 300mm of the shower appliance, as heat transfer can damage components.
7. When installed, the top of the shower unit must be at least 75mm lower than the base of the cold water storage cistern to prevent the pump being run dry without water.

8. A dedicated COLD water supply must be taken directly from the COLD water cistern to the shower. This draw-off must be on the opposite side of the cistern to the float operated valve to reduce the risk of air entering the unit.
9. The action of the pump is to increase the flow rate. If the supply pipework cannot handle the resulting flow rate then:
  - 9a. The anticipated flow rate may not be achieved.
  - 9b. Air may be drawn into the HOT supply from the vent pipe causing spluttering and temperature fluctuations at the sprayhead.
10. Fullway isolating valves or fullway lever valves MUST be fitted on the HOT and COLD water supplies to the shower as an independent means of isolating the water supplies should maintenance or servicing be necessary. DO NOT use stop taps or ball-o-fix type valves which restrict flow.

### ELECTRICAL NOTES

1. The installation must comply with BS 7671 Requirements for electrical Installations' (IEE wiring regulations). Make sure the incoming hot and cold water supplies to the shower are adequately earth bonded.
2. DO NOT turn on the electrical supply until the plumbing connections have been completed. Only then can the electricity be switched on in order to power the motor to turn water on to the shower when commissioning. The shower must not be operated dry without water.
3. The mains supply must be 230/240V, at 50Hz, connected to the unit via a double pole switched 3 Amp fused connection unit (not supplied) with a minimum 3mm contact separation gap in each pole.
4. In accordance with 'The Plugs and Sockets etc. (Safety) Regulations 1994', this unit is intended to be permanently connected to the fixed

## SECTION 3 GENERAL INTRODUCTION

### INTRODUCTION

This book contains all the necessary fitting and operating instructions for your Galaxy power shower.

Take time to read this book thoroughly and familiarise yourself with all instructions BEFORE beginning installation. Please keep it for future reference.

The shower installation must be carried out by a suitably competent person and in the sequence of this instruction book.

Care taken during the installation will ensure a long and trouble-free life from your shower.

**IMPORTANT: All plumbing connections must be completed BEFORE making the electrical connections.**

**IMPORTANT: The fittings on the pipe Inlet elbows are of the push-in type. The pipework must be cut with a pipe cutter and all burrs and rough edges removed from the end of the tube. The fittings can be used with copper and plastic pipe. Where chrome plated pipe is used, remove the first 25mm of plating.**

**Note :** The pump inside this product is rated 15 minutes on / 45 minutes off duty cycle.

### SAFETY WARNINGS

#### WARNING!

**The power shower does not contain a thermostatic valve – it will not shut off in the event of failure of either the HOT or COLD water supplies.**

- DO NOT insert fingers into the push-in Inlet fittings. Doing so could cause injury.
- Under no circumstances must this product be connected to mains COLD or HOT water supplies.** Failure to comply will invalidate the guarantee.
- The shower MUST NOT be used if suspected of being frozen.
- The outlet of this appliance must not be connected to any form of tap or fitting not recommended by the manufacturer.
- The sprayhead cartridge must be cleaned regularly to remove scale and debris.
- This appliance must be earthed.
- Switch off immediately at the isolating switch if water ceases to flow during Use. Contact Customer Service for advice.
- If it is intended to operate the shower outside the guidelines laid out in site requirements, contact Customer Service for advice.

**In the interest of electrical safety a 30mA residual current device (RCD) should be installed in all UK 230V electric and pumped shower circuits. This may be part of the consumer Unit or a separate unit.**

### SPECIFICATIONS HOT water temperature

Maximum temperature 65°C.

BS 6700 recommends that the temperature of stored water should never exceed 65°C. A stored water temperature of 60°C is considered sufficient to meet all normal requirements and will minimise the effects of scale in hard water areas.

#### Maximum static inlet pressures

1 bar or 10m (supplies must be gravity fed At nominally equal pressures).

#### Minimum static inlet pressure

0.0075 bar or 75mm (required to prime the integral centrifugal pump).

## SECTION 4 SITE REQUIREMENTS

### Water

The installation must be in accordance With Water Regulations/Byelaws and BS 6700. For correct operation of this shower unit, both HOT and COLD water supplies to the appliance must be gravity fed, at nominally equal pressures, from a cold water storage cistern and a hot water storage cylinder.

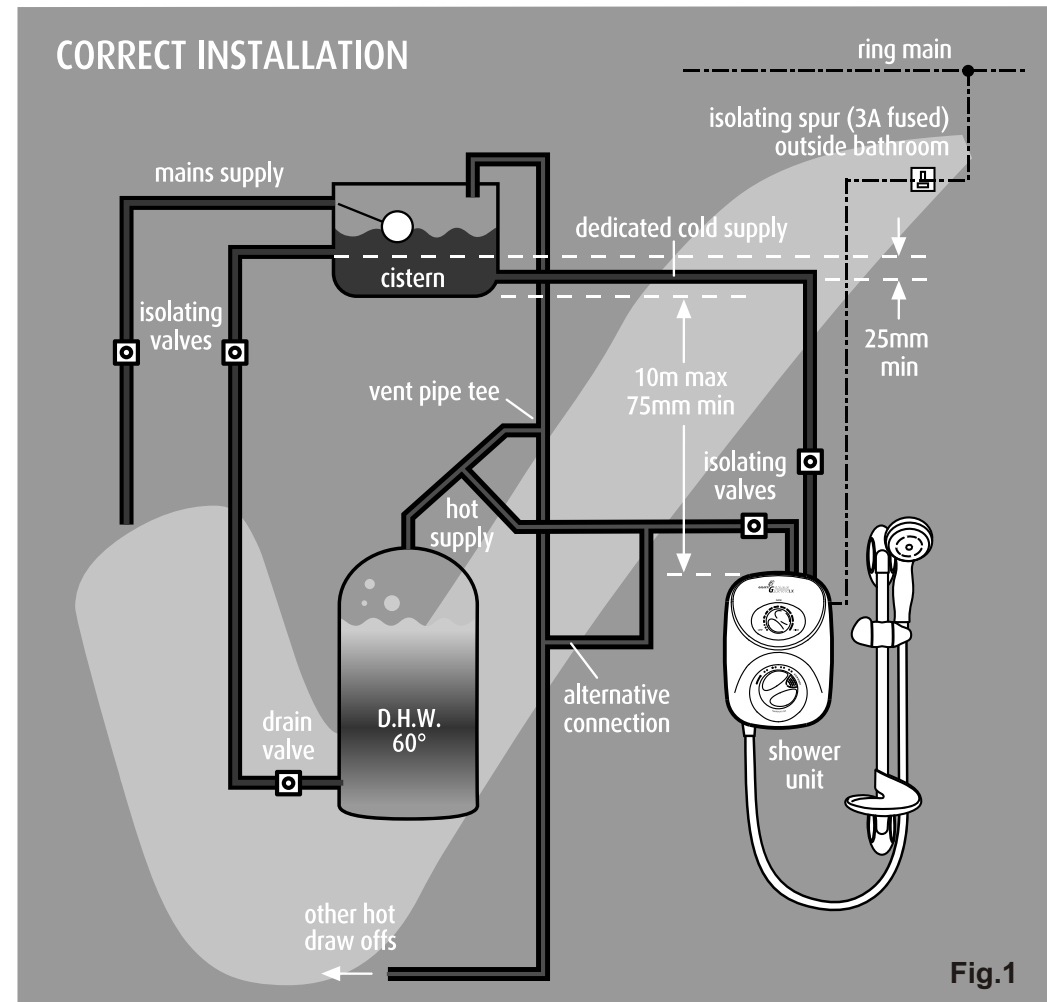

Fig.1

The water circuit should be installed so that the flow is not significantly affected by other taps and appliances being operated elsewhere on the premises.

Fig.1 shows a recommended installation where the HOT water supply for the shower is made via a tee connection on the underside of the horizontal section of pipework from the cylinder. Alternatively, the connection can be taken from the HOT supply pipe to other outlets as long as it is the first draw-off below the ventilation pipe Tee.

Fig.2 illustrates all the incorrect connections that must be avoided.

All pipework to the shower unit must be routed where it remains below the level of water in the cistern. In the case of horizontal sections of pipework in lofts, it may be necessary to fit automatic air vents at high points on the supplies to remove the possibility of air locks.

For the operation of the shower only, it is recommended that the COLD water storage cistern is capable of holding at least 114 litres (25 gallons). Where other HOT and COLD outlets are likely to be in use simultaneously, the storage capacity should be increased to 228 litres (50 gallons) in accordance with BS 6700.

Do ensure compliance with the Water Regulations/Byelaws.

DO NOT connect to a combination cylinder Unless there is a guaranteed 114 litre COLD supply to the cylinder as the shower can deliver up to 14 litres per minute. It is advisable to check that the infill rate from the float operated valve meets the output requirements.

It is recommended that there is a minimum of approximately 114 litres (25 gallons) of HOT water storage per appliance.

**The shower MUST NOT be connected to the mains cold water supply.**

**DO NOT use jointing compounds.**

#### GENERAL INSTALLATION NOTES

- DO NOT take risks with plumbing or electrical equipment.
- DO NOT install this unit in a position where it could become frozen
- Isolate electrical and water supplies BEFORE proceeding with installation Work.
- Shower control MUST be fed from a COLD water storage cistern and hot water cylinder that provides nominally equal pressures.
- The unit must be mounted onto the finished wall surface (on top of tiles).  
DO NOT tile up to the unit after fixing to the wall.
- If installing with rear inlet supplies, it is recommended the supply pipework is sealed to the wall so as to prevent water from leaking back into the wall.

- In solid wall installations, the supply pipework should be housed within ducting in order to allow some free lateral movement when making connections and to ensure compliance with requirements of accessibility of pipes and pipe fittings.

## SITING OF THE SHOWER

### WARNING!

**The shower must not be positioned where it will be subject to freezing conditions.**

**IMPORTANT: If mounting onto a tiled wall always mount the unit on the surface of the tiles. NEVER tile up to the Unit.**

Refer to **fig.3** for correct siting of the shower. Position the unit vertically where it will NOT be in direct contact with water from the sprayhead.

**Note:** Allow sufficient room between the Ceiling and the shower unit to access the top cover screw.

Position the shower and sprayhead on the Wall so that all controls can be comfortably reached when using the shower.

The sprayhead and riser rail can be positioned either side of the shower unit.

## INCORRECT INSTALLATION CONNECTIONS

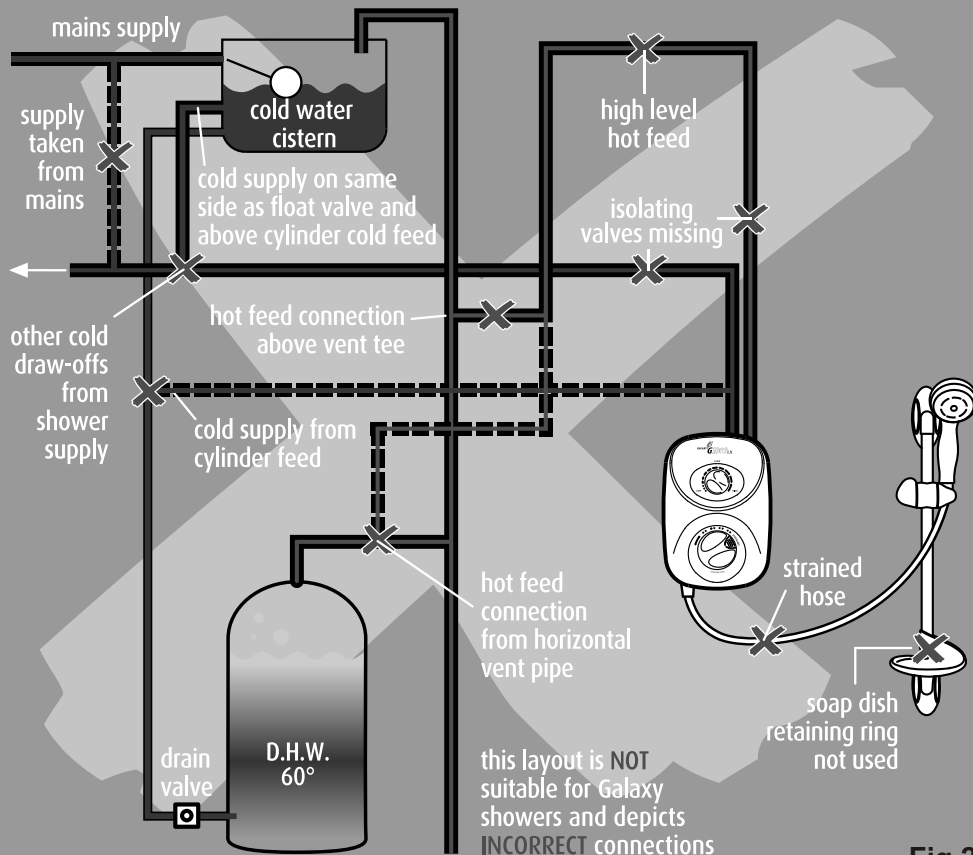

Fig.2

## PRODUCT POSITIONING GUIDE

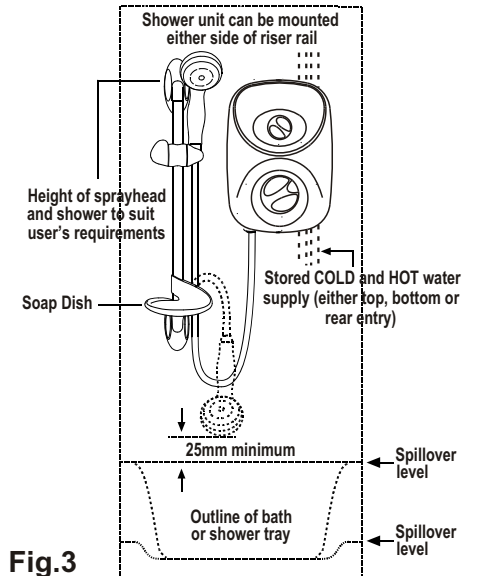

Fig.3

**Note:** Water Regulations require the sprayhead be 'constrained by a fixed or sliding attachment so that it can only discharge water at a point not less than 25mm above the spill-over level of the relevant bath, shower tray or other fixed appliance'. But if the sprayhead can be placed within a bath, basin or shower tray, then a device must be fitted to prevent back-flow.

must be positioned 25mm below the COLD feed connection to the hot water cylinder on the opposite side of the cistern to the float operated valve (see fig.1). This minimises air ingress into the pipework.

Plumbing options other than those outlined in these fitting instructions could impair the performance. For example, if HOT and COLD connections are made after draw-off points to other outlets, (eg. washing machine, taps, etc.) it could result in unstable flows and temperatures should other appliances operate at the same time.

Run the HOT and COLD pipework to the shower position. Make sure that the pipework does not rise above the level of water in the COLD cistern at any point to avoid air locks. Under normal site conditions 15mm pipework will be adequate.

Decide the position of the shower. Cut the pipework to the dimensions relevant to the chosen direction of water entry into the shower.

**IMPORTANT:** When fitting the elbows to incoming pipework, make sure the elbow collets are fully engaged with the pipe.

Dimensions are shown in fig.4.

**Note:** The pipe inlets are marked for HOT and COLD connections – left-hand side for all HOT connections.

**IMPORTANT:** The fittings on the inlet elbows are the push-in type. The pipework must be cut with a pipe cutter and all burrs and rough edges removed from the end of the tube. The fittings can be used with copper and plastic pipe.

If using chrome plated copper pipe, remove the first 25mm of plating completely from the connecting surfaces. If not completely removed then the collet will not grip the pipe and under pressure the pipe may be

forced out.

**Note:** Pipework must be clipped or fixed to the wall so that it cannot be moved or removed without the aid of a tool.

**Note:** The pipe inlets contain filters. These should be periodically removed and cleaned in order to maintain the performance of the shower. See section 'cleaning' on how to access the filters.

**IMPORTANT:** The inlets contain check valves, so before completing the connection of the water supplies to the shower flush out the pipework to remove all swarf and system debris that may cause damage to internal parts. This can be achieved by connecting a hose to the pipework and turning on the water supplies long enough to clear the debris to waste.

**IMPORTANT:** Two factory fitted blanking plugs are fitted to the BOTTOM pipe inlets. These should be left in position if TOP or REAR pipe entry is required. For BOTTOM entry only, the two plugs MUST be removed and refitted into the TOP pipe inlets. Failure to fit the blanking plugs will result in the unit working erratically and flooding can occur.

You will need to remove the two entry point cut-outs in the backplate, by either breaking out or by using a knife or junior hacksaw before the blanking plugs can be removed. Whilst holding back on the collet, pull out each plug with pliers. When refitting the plugs in the TOP pipe inlets, make sure they are pushed fully home.

## SECTION 5 INSTALLATION - PLUMBING CONNECTIONS

### Plumbing to be carried out before Wiring

**Note:** The outlet of the shower must not be connected to any tap or fitting not recommended by Glen Dimplex.

DO NOT use jointing compounds on any pipe fittings for the installation.

When connecting pipework avoid using tight 90° elbows. Swept or formed bends will give optimum performance.

Isolate the mains water supply to the COLD water cistern.

Drain the HOT and COLD pipes by opening all taps.

The HOT water supply can be taken from the HOT supply pipe from the cylinder, making sure that it is the first draw-off below the ventilation pipe tee in order to minimise the effects of water draw-off elsewhere in the house (see fig.1).

**Note:** There must not be any other draw-offs between the take-off point and the shower. A dedicated COLD water supply must be taken directly from the COLD

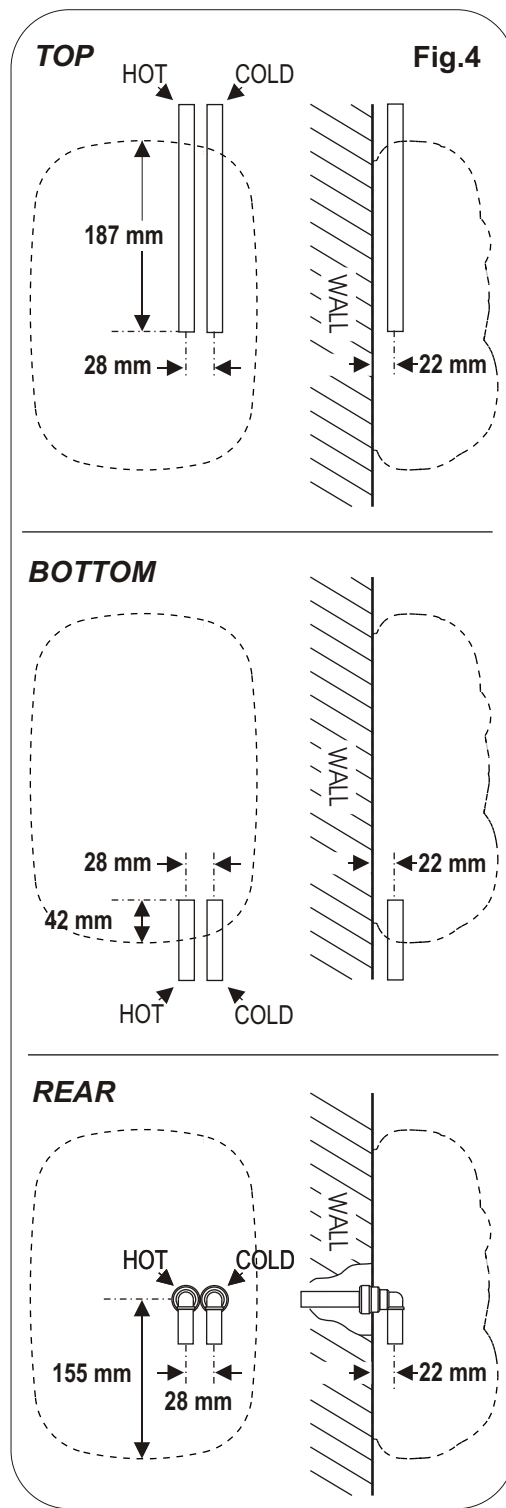

## SECTION 6 INSTALLATION - REMOVING THE COVER

The G1000LX power shower is designed to be mounted directly on to a flat surface, it is essential that the mounting surface is

Absolutely flat, otherwise the base will distort causing difficulty in fitting the cover assembly.

Before removing the cover please ensure that the temperature control knob (bottom knob) is turned fully clockwise to the STOP position.

Remove the two screws that secure the cover to the back plate.

**During installation be careful not to damage the lead that connects the unit to the cover assy.**

Drill 3 holes 5.5mm dia, 45mm deep to accept raw plugs.

Decide whether the water supply will be entering the unit from the TOP, BOTTOM or from the REAR.

If pipe work is to enter from the TOP of the unit, then remove the slide fit inserts.

If pipe work to enter from BOTTOM of unit, then using a sharp Stanley knife, carefully remove the knockout components moulded into the back plate. Remembering to fit blanking plugs into TOP pipe entry apertures.

If pipe work to be supplied from rear, ensure pipe work coming out of wall are the correct length.

Ensure cabling is either pushed in to the channel provided to ensure it does not get trapped behind the unit.

First screw, part way in, the 2 top mounting screws while the 3rd (bottom screw is inserted. After completing installation of the mounting screws, screw firmly into place.

If unit is to be mounted on a cavity wall, it may be necessary to use appropriate fixings.

## SECTION 7 INSTALLATION - ELECTRICAL CONNECTION

### WARNING!

**This unit must be earthed. Isolate the Electrical supply before starting.**

The supply cable must conform to relevant tables in current IEE regulations. In most cases 1mm<sup>2</sup> twin and earth will be adequate.

The electrical rating of the shower is on the rating label within the unit.

**SWITCH OFF THE ELECTRICITY SUPPLY AT THE MAINS.**

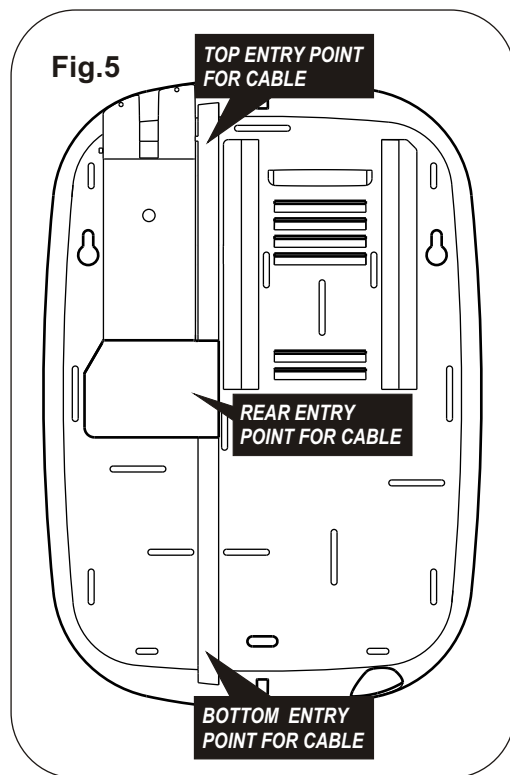

Cable entry points are shown in fig.5. Conduit entry can only be from the rear. Route the cable into the shower, taking care to avoid the area of the wall fixings and connect to the terminal block as follows:

Earth cable to terminal marked **E**

Neutral cable to terminal marked **N**

Live cable to terminal marked **L**

**IMPORTANT: Fully tighten the terminal block screws and check that no cable insulation is trapped under the screws.**

**Note:** The supply cable earth conductor must be sleeved.

The earth continuity conductor of the electrical installation must be effectively connected electrically to all exposed metal parts of other appliances and services in the room in which the shower is to be installed, to conform to current IEE regulations.

**Note:** Fuses do not ensure user protection against electric shock. In the interest of electrical safety, all mains electric and pumped showers should be fitted with a 30mA residual current device (RCD). This may be part of the consumer unit or a separate unit.

**DO NOT switch on the electricity supply until the water has been turned on to the unit and connections have been tested for leaks.**

**IMPORTANT: The cover may be left off initially only for commissioning.**

## SECTION 8 COMMISSIONING

1. Ensure that the temperature control valve (bottom knob) is turned off (fully

clockwise.

2. Remove cover (remove screw at bottom and top of unit).
3. Connect water supplies as 'Section 5' in installation instructions.
4. Connect electric supply as 'Section 7' of installation instructions – **do not switch on yet.**
5. Switch water supplies on – check for any leaks in pipe work.
6. Refit cover – connecting plug and socket from printed circuit board and cover assy.
7. Connect flexible hose (supplied) and point to waste (ensure end of hose is below the shower unit).
8. Turn top dial (flow control) to maximum Flow (fully clockwise).
9. Turn Temperature control knob (bottom knob) to vertical position.

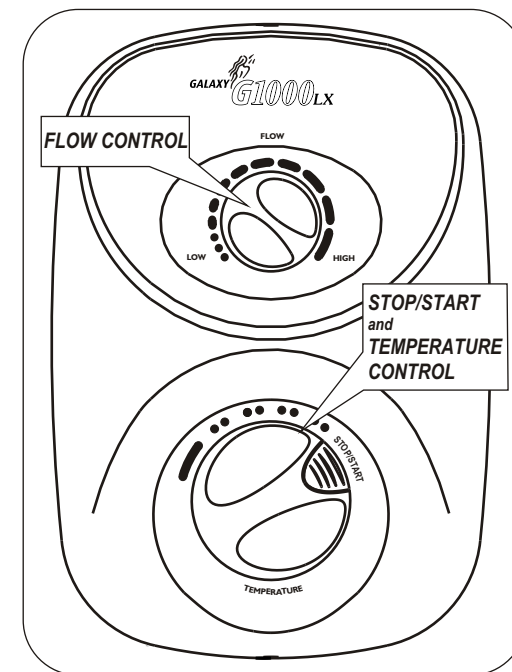

- 9a. Leave water running until a steady flow of water is visible.
10. Turn temperature control knob (anti clockwise) to override position.
11. Depress override button and turn knob anti-clockwise to furthest position.
- 11a. Leave water running until hot water becomes an even flow.
12. Switch unit off by turning temperature control knob fully clockwise.
13. Switch power supply on to unit.
14. Repeat numbers 8 – 12.
15. Fit showerhead (supplied).
16. Unit is now ready for use.

**IMPORTANT:**  
**This procedure is used to ensure that there are no air locks in your system. Failure to follow this procedure may result in damage to your unit. This damage will not be covered by your manufactures warranty.**

## SECTION 9

### RISER RAIL & SOAP DISH FITTING INSTRUCTIONS

#### TIPS

A piece of insulating or masking tape applied to the wall before marking out the fixing holes will help stop the drill from wandering, particularly on tiled surfaces. When working near a basin or bath, insert the plug in the waste fitting so that small parts cannot be lost. Take care not to drop accessories or tools into basin or bath.

#### CAUTION

Check there are no hidden cables or pipes before drilling holes for wall plugs. Exercise great care when using power tools near water. The use of a residual current device (RCD) is recommended.

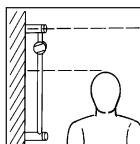

1. Establish position for the riser rail, and mark the wall for the *lower* mounting bracket. Make allowances for the tallest person likely to use the shower regularly.

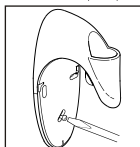

2. Use a No 10/5.5mm masonry drill to make a hole 35mm deep, and fit the wall plug. (*NB some wall constructions may require the use of alternative types of wall fixings*). Screw the lower bracket base to the wall.

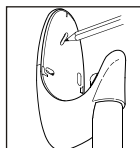

3. Locate the crimped end of the riser rail (Figure 4) into the mounting bracket, then fit the upper bracket. Ensure the rail is vertical, then mark the wall for the fixing.

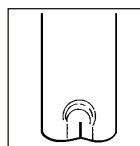

4. The crimped end of the riser rail. *NOTE If it is necessary to shorten the rail, use a junior hacksaw to cut the excess material from the plain end of the rail.*

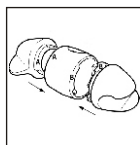

5. The three components that comprise the Handset Height Adjuster assembly are produced with alphabetical 'A's and 'B's moulded into the end section of each part. Simply just match the

letter identification of each part with the central piece i.e. 'A' to 'A' and 'B' to 'B' for correct assembly.

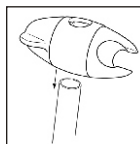

6. With the showerhead height adjuster lever set a 3 o'clock and the showerhead holder in the upright position, slide the assembly onto the rail. Tighten to the rail by turning the lever.

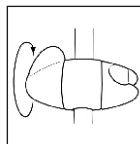

7. To lock the Handset Height Adjuster at your chosen position on the rail. Turn the lever up right. This action is also used for holding the showerhead at the angle required.

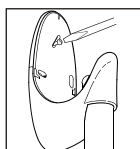

8. Re-assemble the rail and screw the upper mounting bracket in place.

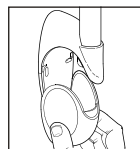

9. Slide the end cap onto the mounting brackets.

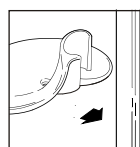

10. Snap the soap dish onto the rail below the holder assembly.

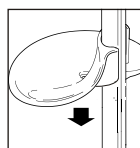

11. Slide soap dish down the rail to required position.

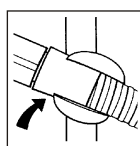

12. Firmly attach flexible hose to the showerhead making sure sealing washer is in place. *NOTE the adjustable slider grips the conical end of the hose, not the handle of the showerhead.*

#### Maintenance:

Clean regularly with a non-abrasive liquid bathroom cleaner.

## SECTION 10

### CLEANING THE FILTERS

#### WARNING!

**Instructions for INSTALLERS and SERVICE ENGINEERS - ONLY!**

**Note:** Turn off the electricity and both HOT and COLD water supplies to the unit before proceeding further.

Before removing the cover please ensure that the temperature control knob (bottom knob) is turned fully clockwise to the STOP position.

Remove the two screws - top and bottom - that secure the cover to the back plate.

**Be careful not to damage the lead that connects the unit to the cover assy.**

Remove the single retaining screw from either the upper or lower filter cover, depending upon whether top/rear entry or bottom entry is used. Pull off the filter cover. Carefully hook out the filters together with 'O' rings. Thoroughly clean and replace making sure the 'O' rings are in position.

Refit the filter cover and secure with the retaining screw.

Refit cover - connecting plug and socket from printed circuit board and cover assembly.

Secure with the retaining screws.

Switch on the electricity supply to the unit and then turn on both water supplies.

## SECTION 11

### SHOWERHEAD CLEANING INSTRUCTIONS

#### IN SHOWER MAINTENANCE



To break away scale deposits on a daily basis simply rub your thumb over the rubber nipples whilst the shower is running.

The showerhead should be cleaned periodically to remove limescale or debris which will reduce the performance of the shower. The frequency of cleaning will vary according to local water quality. In hard water areas cleaning will be needed more often than in soft water areas. A liquid non-abrasive bathroom cleaner may be used on external surfaces of the handset.



1. Engage the key into the spray cartridge recesses and turn anti-clockwise to unscrew.

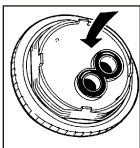

2. Remove the two small black 'O' rings from the rear of the spray cartridge, and rinse 'O' rings clean.

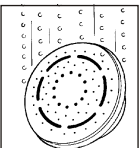

3. If deposits are stubborn, immerse and soak the spray cartridge for several hours in a proprietary limescale remover. Then with a small stiff bristled brush scrub the spray cartridge.

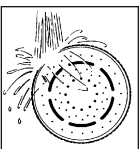

4. Ensure all traces of limescale and limescale remover are rinsed off.



5. Thoroughly clean and rinse the inside of the showerhead.

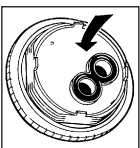

6. Replace the two black 'O' rings on the rear of the spray cartridge. A light smear of petroleum jelly will ensure an easy location into the grooves.



7. Refit cartridge to the showerhead and tighten with the spray key.



## GUARANTEE

Glen Dimplex UK Ltd guarantee this Galaxy product for a period of two years, from date of purchase, against mechanical and electrical defects arising from faulty materials or from poor workmanship, providing the product has been installed by a competent person in accordance with the fitting instructions.

Glen Dimplex UK Ltd undertake to repair or replace, at their discretion, without charge, provided the product has been properly maintained and operated in accordance with the operating instructions. Any component found to be defective during this period, as the result of misuse or damage, or the effects of scaling, will not be covered by this guarantee.

This product must not be modified, repaired or taken apart except by a person authorised by Glen Dimplex UK Ltd.

This Guarantee is only valid within the United Kingdom and does not cover product used commercially.

This Guarantee does not affect your statutory rights.

**Glen Dimplex UK Ltd.,  
Millbrook House,  
Grange Drive  
Hegde End, Southampton SO30 2DF  
Telephone: 0845 600 5111 -  
Fax: 01489 773050 -  
Website: [www.galaxy-showers.com](http://www.galaxy-showers.com)**